



# Brazed Plate Heat Exchanger



ASME  
Certified



KHK  
Japan

KRAIA  
Korea

CRN  
Certified



**Innovation · Quality · Responsibility · Honor**

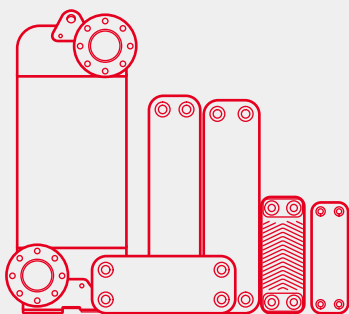

# Index

Company Profile.....	2
Certificate.....	3
Series.....	4
Why KAORI ?.....	5
Brazed Plate Heat Exchanger Dimension.....	6
K Series-Standard Brazed Plate Heat Exchanger.....	8
R Series-High Heat Transfer Performance Brazed Plate Heat Exchanger.....	14
Z Series-Large Diagonal Flow Brazed Plate Heat Exchanger.....	16
C Series-CO <sub>2</sub> Super High Pressure Brazed Plate Heat Exchanger.....	18
B Series-Asymmetric Brazed Plate Heat Exchanger.....	20
A Series-Air Dryer Brazed Plate Heat Exchanger.....	21
D Series-Double Wall Brazed Plate Heat Exchanger.....	22
E/F Series-Low Pressure Brazed Plate Heat Exchanger.....	23
I Series-Impact Resistant Brazed Plate Heat Exchanger.....	24
Q Series-Oil Cooler Brazed Plate Heat Exchanger.....	25
H/T Series-High Temperature Brazed Plate Heat Exchanger.....	26
M Series-Corrosion Resistant Brazed Plate Heat Exchanger.....	27
Standard Connections.....	28
Installation.....	29

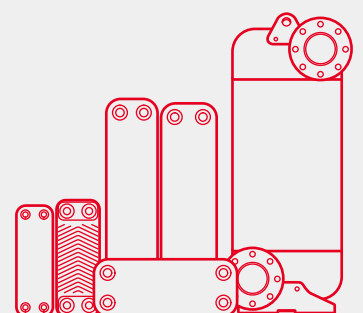

## Company Profile

KAORI was established in 1970, insisting on pursuing innovative technology and manufacturing world-class products as its main goal. Consistently improving, researching, and importing new technology, KAORI launched the brazed plate heat exchanger division in 1994, and the quality system was ISO9001 certified in 1995; afterward KAORI brazed plate heat exchanger obtained numerous patents and certificates. In order to fulfill the increasing demand from the worldwide market, Kaohsiung plant and Ningbo plant were built in 2002 and 2005 to provide larger production capacity. KAORI brazed plate heat exchanger is the No.1 brand in Taiwan and has been exported to more than 70 countries.

## KAORI Brazed Plate Heat Exchanger Plants



Chung-Li Taiwan Plant



Kaohsiung Taiwan Plant



Ningbo China Plant

## Facility and Test Equipment



Vacuum Furnace



Continuous Pressing

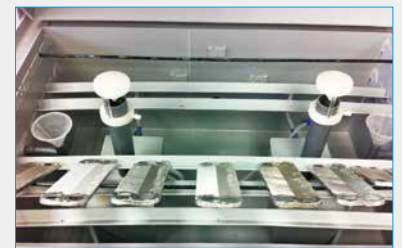

Salt Spray Test



CO<sub>2</sub> High Pressure Test



Helium Leakage Test



Thermal Shock Tester



Performance Test



Pressure Leakage Test



Burst Test

# Certificate

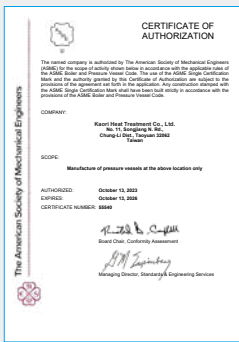

ASME

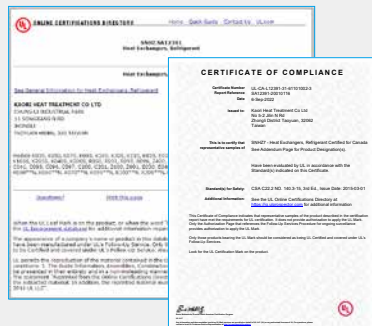

UL



CRN



Japan KHK



ISO9001:2015



ISO14064-1



ISO14067



ISO45001



CE/ PED

# Patent



CO<sub>2</sub> High Pressure BPHE Patents in Taiwan, China, Japan and Germany

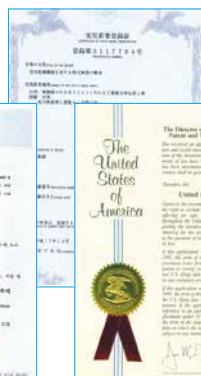

Air Dryer BPHE Patents in Taiwan, Japan, Korea, and USA

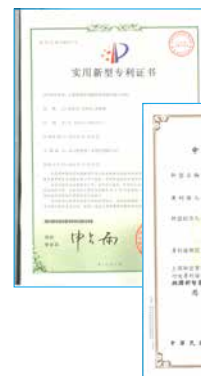

Double Wall BPHE Patents in Taiwan, Germany and China

High Quality from **Taiwan**

# Series

Range	K Series	R Series	Z Series	C Series	B Series	A Series	D Series	E/F Series	
	Standard	High Heat Transfer Performance	Large Diagonal Flow	Super High Pressure	Asymmetric	Air Dryer	Double Wall	Boilers	
<b>Solutions</b>									
Max. Working Pressure	45bar	45bar	45bar	140bar	45bar	16bar	45bar	20bar	
Characteristic	Standard Dual Circuits	Micro Channel Design	Large Heat Capacity High Flow Rate	R744(CO <sub>2</sub> )	Reduction in refrigerant filling and pressure drop	Evaporator, Separator and Precooler all in one	Prevent Fluid Contamination	Low Pressure	
Brazing Material	Copper/Nickel	Copper	Copper	Copper	Copper	Copper	Copper	Copper	
<b>Applications</b>	HVAC	●	●	●	●	●	●		
	Refrigeration	●	●	●	●	●			
	Heat Pump	●	●	●	●	●		●	
	Chiller	●	●	●	●	●			
	District Heating & Cooling	●	●	●		●			
	Solar Heating	●	●	●		●			
	Swimming Pool								
	Air Dryer						●		
	Process Cooling	●		●		●		●	●
	Heat Recovery	●		●		●			
	Temperature Controller	●				●			●
	Laser Cutting/ Welding Machine	●				●			
	Hydraulic Cooling	●		●		●			
	Energy Industry	●		●		●			
	ORC	●		●		●			
	Fuel Cell, CHP	●				●			●
	Wind Power-Gear Box	●		●		●			
Marine & Transport	●		●		●				
<b>Solutions</b>	Evaporator	●	●	●	●	●			
	Condenser	●	●	●	●	●	●		
	De-superheater/Subcooler	●	●	●	●	●	●		
	Economizer	●	●	●	●	●	●		
	Oil Cooler	●				●	●		
	Pre-cooler/ Pre-heater	●	●	●	●	●	●		
	Air Cooler	●		●	●	●	●		



# Brazed Plate Heat Exchanger Dimension

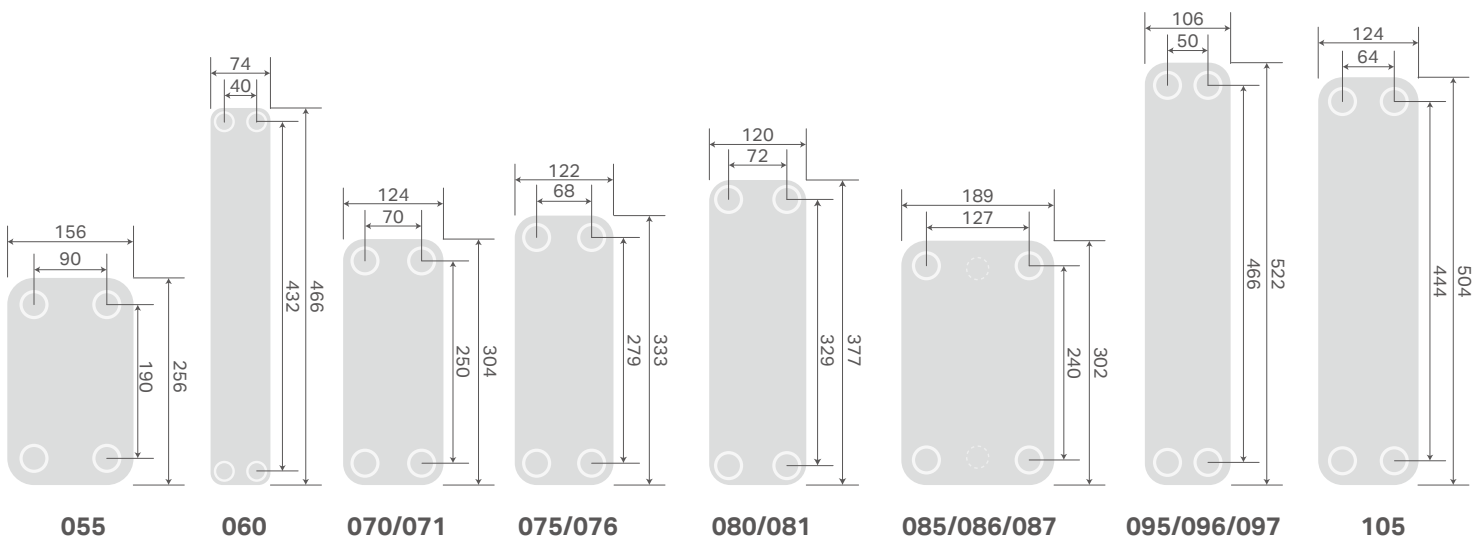
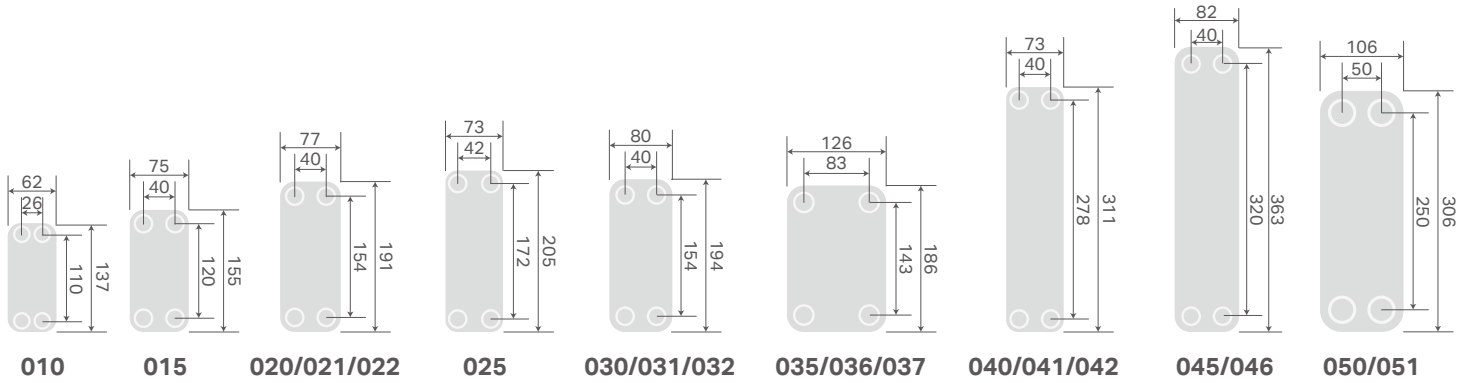



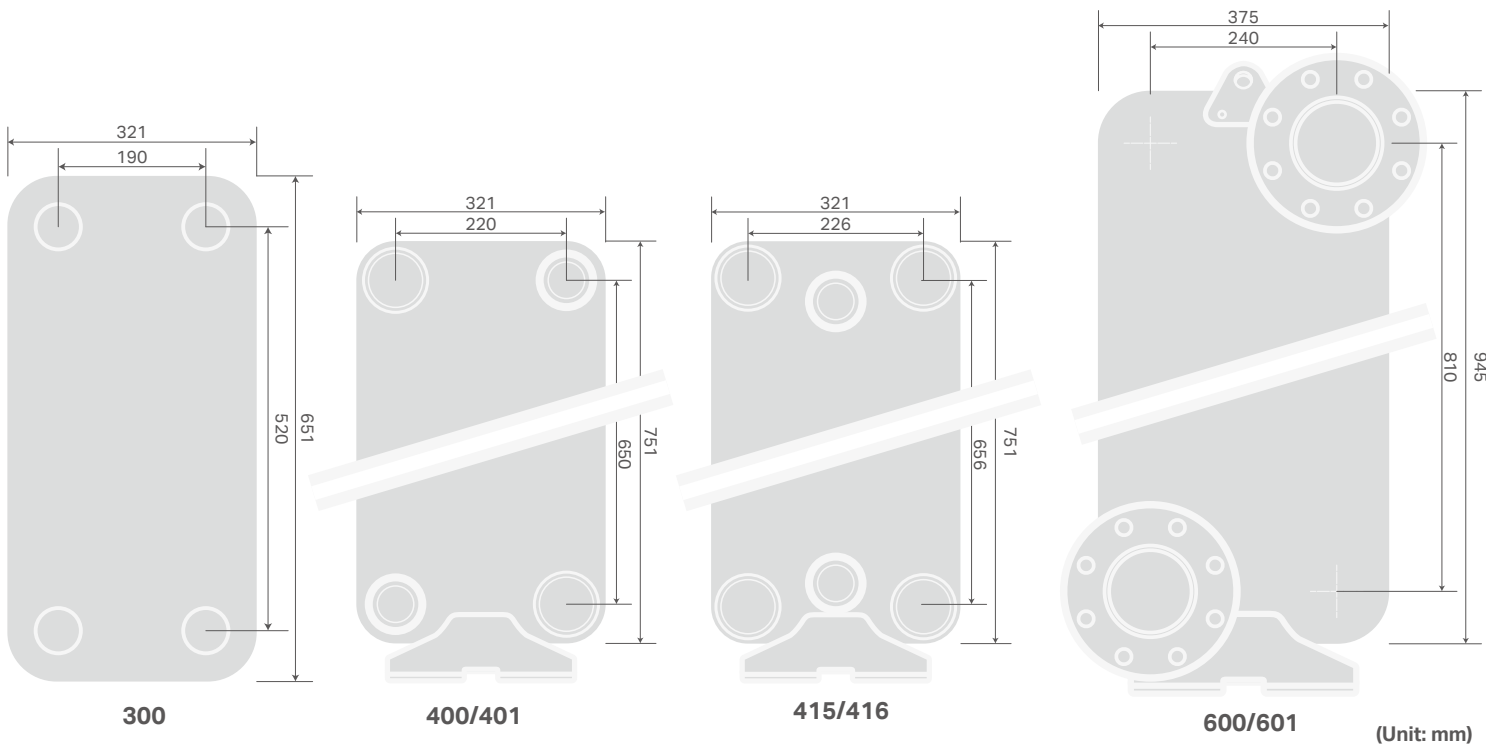
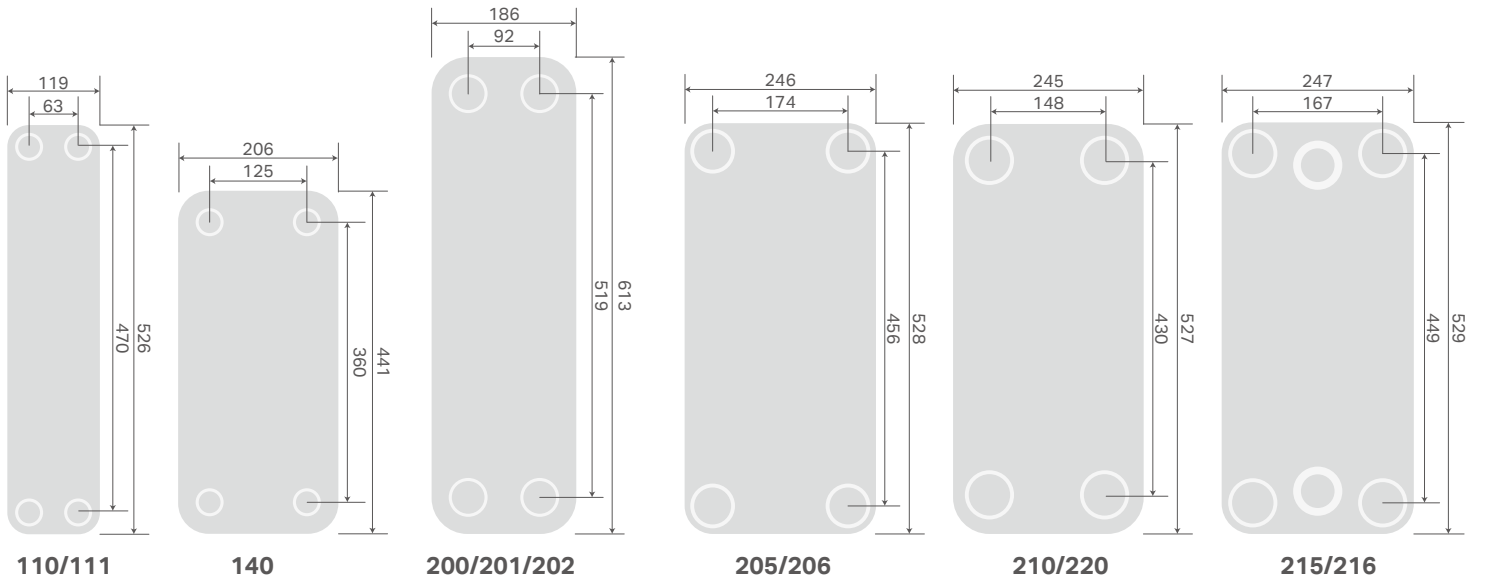

\* Due to different patterns of each series, precise dimension details will be specified in respective pages.

# K Series-Standard Brazed Plate Heat Exchanger



K series is the series with the most complete range in sizes and widely used in heating and cooling applications.

Main application: HVAC, heat pump, chiller, oil cooler, district heating and cooling.

K-S Extra Strength: Kaori "S" type BPHE is designed to withstand max. working pressure 45 bar for R410A Application.

K-D True Dual Circuits: Kaori "D" type BPHE is designed to handle two compressors with true dual refrigerant circuits pattern; perfect choice for both full and half load operation.

Brazing Material	Copper	Copper (Extra Strength)	Nickel
	(A1,A2/B1,B2)		
Max. Working Pressure (bar)	30/30	45/30	10/10
Max. Working Temperature (°C)	200°C		

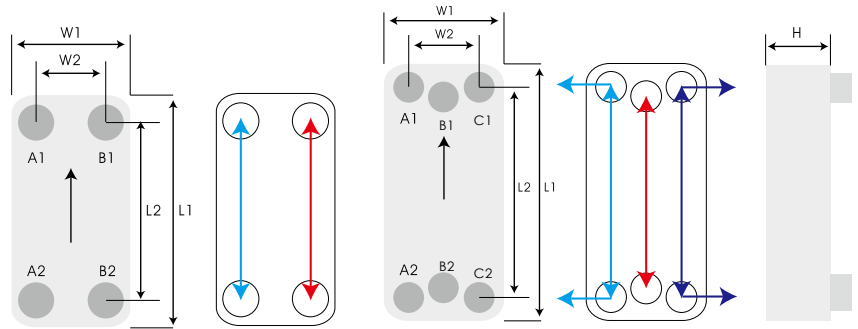

K415/K215D: True Dual Circuits- 6 Connections

Model	L1 (mm)	L2 (mm)	W1 (mm)	W2 (mm)	H Thickness (mm)	Weight*(kg) (Without Connection)	Volume/Channel (liter)	Total Volume (liter)
K010	137	110	62	26	6.50+1.70*N	0.15+0.025*N	0.011	(N-1)*0.011
K015	155	120	75	40	8.00+1.75*N	0.20+0.034*N	0.016	(N-1)*0.016
K025	205	172	73	42	6.70+2.27*N	0.48+0.040*N	0.025	(N-1)*0.025
K030	194	154	80	40	9.00+2.20*N	0.50+0.047*N	0.025	(N-1)*0.025
K040	311	278	73	40	9.00+2.30*N	0.79+0.070*N	0.040	(N-1)*0.040
K050	306	250	106	50	10.0+2.38*N	1.19+0.116*N	0.055	(N-1)*0.055
K060	466	432	74	40	10.0+2.30*N	1.19+0.100*N	0.064	(N-1)*0.064
K070	304	250	124	70	10.0+2.38*N	1.38+0.134*N	0.065	(N-1)*0.065
K095	522	466	106	50	11.0+2.38*N	2.83+0.204*N	0.095	(N-1)*0.095
K105	504	444	124	64	11.0+2.38*N	3.23+0.230*N	0.107	(N-1)*0.107
K200	613	519	186	92	14.0+2.40*N	6.89+0.415*N	0.206	(N-1)*0.206
K205	528	456	246	174	14.0+2.40*N	7.30+0.480*N	0.232	(N-1)*0.232
K210*	527	430	245	148	11.5+2.85*N	6.68+0.465*N	0.289	(N-1)*0.289
K220	527	430	245	148	14.0+2.40*N	7.94+0.440*N	0.289	(N-1)*0.289
K215	529	449	247	167	13.0+2.40*N	8.31+0.480*N	0.220	(N-1)*0.220
K415	751	656	321	226	14.0+2.40*N	29.78+0.87*N	0.414	(N-1)*0.414

Model	L1 (mm)	L2 (mm)	W1 (mm)	W2 (mm)	H Thickness (mm)	Weight*(kg) (Without Connection)	Volume/Channel (liter)	Total Volume (liter)
K025S	205	172	73	42	6.70+2.27*N	0.51+0.040*N	0.025	(N-1)*0.025
K030S	194	154	80	40	11.0+2.20*N	0.96+0.047*N	0.025	(N-1)*0.025
K040S	311	278	73	40	9.00+2.30*N	0.84+0.070*N	0.040	(N-1)*0.040
K050S	306	250	106	50	12.0+2.38*N	2.39+0.116*N	0.055	(N-1)*0.055
K060S	466	432	74	40	10.0+2.30*N	1.23+0.100*N	0.064	(N-1)*0.064
K070S	304	250	124	70	12.0+2.38*N	2.52+0.134*N	0.065	(N-1)*0.065
K095S	522	466	106	50	11.6+2.38*N	3.77+0.204*N	0.095	(N-1)*0.095
K105S	504	444	124	64	15.0+2.38*N	5.47+0.237*N	0.107	(N-1)*0.107
K200S	613	519	186	92	17.0+2.40*N	12.12+0.415*N	0.206	(N-1)*0.206
K205S	528	456	246	174	16.5+2.40*N	13.36+0.480*N	0.232	(N-1)*0.232
K210S*	527	430	245	148	15.4+2.85*N	12.09+0.465*N	0.289	(N-1)*0.289
K215S	529	449	247	167	16.0+2.40*N	13.80+0.480*N	0.220	(N-1)*0.220

N: number of plates

\* Working pressure for K210: 16 Bar. Working pressure for K210S: 30 Bar.

# Model Selection Chart

## R32 vs. Water Condenser

Based on ARI-450 Standard

RT	kW	BTU/H	K025S	K030S	K040S	K050S	K060S	K070S
0.2	0.70	2400	K025Sx8	K030Sx8				
0.5	1.76	6000	K025Sx16	K030Sx16	K040Sx8			
1	3.52	12000	K025Sx28	K030Sx28	K040Sx14	K050Sx10	K060SxH10	
1.5	5.27	18000			K040Sx18	K050Sx14	K060SxH12	K070Sx14
2	7.03	24000			K040Sx20	K050Sx18	K060SxH16	K070Sx18
2.5	8.79	30000				K050Sx22	K060SxH18	K070Sx22
3	10.55	36000				K050Sx26	K060SxH22	K070Sx26
4	14.06	48000				K050Sx34	K060SxH30	K070Sx34
5	17.58	60000				K050Sx42	K060SxH38	K070Sx42

## R32 vs. Water Condenser

Based on ARI-450 Standard

RT	kW	BTU/H	K095S	K105S	K200S	K205S	K215SD
4	14.06	48000	K095Sx18	K105Sx18			
5	17.58	60000	K095Sx22	K105Sx22			
7.5	26.37	90000	K095Sx32	K105Sx32			
10	35.16	120000	K095Sx42	K105Sx42			K215SxD22
12.5	43.95	150000	K095Sx54	K105Sx54	K200SxH26	K205Sx26	
15	52.74	180000	K095Sx64	K105Sx64	K200SxH30	K205Sx30	K215SxD30
20	70.32	240000			K200SxH40	K205Sx42	K215SxD38
25	87.9	300000			K200SxH52	K205Sx54	K215SxD50
30	105.48	360000			K200SxH62	K205Sx66	K215SxD58
40	140.64	480000			K200SxH90	K205Sx98	K215SxD82

## R32 vs. Water Evaporator

Based on ARI-480 Standard

RT	kW	BTU/H	K025	K030	K040	K050	K060	K070
0.2	0.70	2400	K025x14	K030x14				
0.5	1.76	6000	K025x24	K030x24	K040x14			
1	3.52	12000	K025x44	K030x44	K040x22	K050x14	K060xH12	
1.5	5.27	18000			K040x32	K050x22	K060xH18	K070x20
2	7.03	24000				K050x28	K060xH24	K070x26
2.5	8.79	30000				K050x32	K060xH26	K070x30
3	10.55	36000				K050x44	K060xH40	K070x42
4	14.06	48000					K060xH50	K070x54
5	17.58	60000						K070x64

## R32 vs. Water Evaporator

Based on ARI-480 Standard

RT	kW	BTU/H	K095	K105	K200	K205	K215D
3	10.55	36000	K095x18	K105x20			
4	14.06	48000	K095x22	K105x26			
5	17.58	60000	K095x26	K105x34			
7.5	26.37	90000	K095x40	K105x50			
10	35.16	120000	K095x54	K105x68			K215Dx30
12	43.95	150000			K200xH32	K205x30	
15	52.74	180000			K200xH40	K205x38	K215Dx38
20	70.32	240000			K200xH52	K205x48	K215Dx46
25	87.9	300000			K200xH64	K205x60	K215Dx58
30	105.48	360000				K205x74	K215Dx66
40	140.64	480000				K205x114	K215Dx90

The above information is for reference only; the data will be different under various working conditions and specifications.

# Model Selection Chart

## R410A vs. Water Condenser

Based on ARI-450 Standard

RT	kW	BTU/H	K025S	K030S	K040S	K050S	K060S	K070S
0.2	0.70	2400	K025Sx8	K030Sx8				
0.5	1.76	6000	K025Sx16	K030Sx16	K040Sx10			
1	3.52	12000	K025Sx28	K030Sx28	K040Sx16	K050Sx12	K060Sx10	K070Sx12
1.5	5.27	18000			K040Sx20	K050Sx16	K060Sx14	K070Sx16
2	7.03	24000			K040Sx24	K050Sx20	K060Sx18	K070Sx20
2.5	8.79	30000				K050Sx26	K060Sx22	K070Sx26
3	10.55	36000				K050Sx32	K060Sx28	K070Sx32
4	14.06	48000				K050Sx42	K060Sx38	K070Sx42
5	17.58	60000				K050Sx52	K060Sx46	K070Sx52

## R410A vs. Water Condenser

Based on ARI-450 Standard

RT	kW	BTU/H	K095S	K105S	K200S	K205S	K215S
4	14.06	48000	K095Sx20	K105Sx20			
5	17.58	60000	K095Sx24	K105Sx24			
7.5	26.37	90000	K095Sx36	K105Sx36			
10	35.16	120000	K095Sx48	K105Sx48			K215SxD22
12.5	43.95	150000			K200Sx26	K205Sx26	
15	52.74	180000			K200Sx30	K205Sx30	K215SxD30
20	70.32	240000			K200Sx40	K205Sx42	K215SxD38
25	87.90	300000			K200Sx52	K205Sx54	K215SxD50
30	105.48	360000			K200Sx64	K205Sx66	K215SxD58
40	140.64	480000			K200Sx96	K205Sx98	K215SxD82
50	175.80	600000				K205Sx170	

## R410A vs. Water Evaporator

Based on ARI-480 Standard

RT	kW	BTU/H	K025	K030	K040	K050	K060	K070
0.2	0.70	2400	K025x12	K030x12				
0.5	1.76	6000	K025x20	K030x20	K040x12			
1	3.52	12000	K025x34	K030x34	K040x20	K050x12	K060xH10	K070x12
1.5	5.27	18000			K040x30	K050x18	K060xH16	K070x16
2	7.03	24000			K040x40	K050x22	K060xH20	K070x20
2.5	8.79	30000				K050x26	K060xH22	K070x24
3	10.55	36000				K050x36	K060xH32	K070x34
4	14.06	48000				K050x46	K060xH40	K070x44
5	17.58	60000				K050x54	K060xH48	K070x52

## R410A vs. Water Evaporator

Based on ARI-480 Standard

RT	kW	BTU/H	K095	K105	K200	K205	K215D
3	10.55	36000	K095x16	K105x18			
4	14.06	48000	K095x20	K105x24			
5	17.58	60000	K095x24	K105x30			
7.5	26.37	90000	K095x38	K105x44			
10	35.16	120000	K095x50	K105x56			K215Dx26
12.5	43.95	150000			K200xH30	K205x28	
15	52.74	180000			K200xH36	K205x32	K215Dx34
20	70.32	240000			K200xH48	K205x44	K215Dx42
25	87.90	300000			K200xH60	K205x56	K215Dx54
30	105.48	360000				K205x70	K215Dx62
40	140.64	480000				K205x108	K215Dx86

The above information is for reference only; the data will be different under various working conditions and specifications.

## Model Selection Chart

### R134a vs. Water Condenser

Based on ARI-450 Standard

RT	kW	BTU/H	K025	K030	K040	K050	K060	K070
0.2	0.70	2400	K025x8	K030x8				
0.5	1.76	6000	K025x16	K030x16	K040x10			
1	3.52	12000	K025x30	K030x30	K040x18	K050x16	K060xH14	K070x16
1.5	5.27	18000			K040x24	K050x22	K060xH20	K070x22
2	7.03	24000			K040x32	K050x28	K060xH24	K070x26
2.5	8.79	30000				K050x34	K060xH30	K070x32
3	10.55	36000				K050x42	K060xH38	K070x40
4	14.06	48000				K050x56	K060xH50	K070x54
5	17.58	60000				K050x68	K060xH60	K070x66

### R134a vs. Water Condenser

Based on ARI-450 Standard

RT	kW	BTU/H	K095	K105	K200	K205	K215D
3	10.55	36000	K095x18	K105x18			
4	14.06	48000	K095x24	K105x24			
5	17.58	60000	K095x28	K105x28			
7.5	26.37	90000	K095x42	K105x42			
10	35.16	120000	K095x56	K105x56	K200xH30	K205x20	K215Dx18
12.5	43.95	150000			K200xH38	K205x26	
15	52.74	180000			K200xH46	K205x30	K215Dx30
20	70.32	240000			K200xH60	K205x42	K215Dx38
25	87.90	300000			K200xH76	K205x54	K215Dx50
30	105.48	360000			K200xH90	K205x66	K215Dx58
40	140.64	480000			K200xH120	K205x98	K215Dx82
50	175.80	600000				K205x138	

### R134a vs. Water Evaporator

Based on ARI-480 Standard

RT	kW	BTU/H	K025	K030	K040	K050	K060	K070
0.2	0.70	2400	K025x12	K030x12				
0.5	1.76	6000	K025x20	K030x20	K040x12			
1	3.52	12000	K025x36	K030x36	K040x20	K050x14	K060xM14	K070x14
1.5	5.27	18000			K040x32	K050x18	K060xM18	K070x18
2	7.03	24000			K040x40	K050x22	K060xM22	K070x20
2.5	8.79	30000				K050x28	K060xM28	K070x26
3	10.55	36000				K050x36	K060xM36	K070x34
4	14.06	48000				K050x44	K060xM44	K070x42
5	17.58	60000				K050x56	K060xM56	K070x54

### R134a vs. Water Evaporator

Based on ARI-480 Standard

RT	kW	BTU/H	K095	K105	K200	K205	K215D
2.5	8.79	30000	K095x16	K105x20			
3	10.55	36000	K095x20	K105x24			
4	14.06	48000	K095x24	K105x30			
5	17.58	60000	K095x30	K105x36			
7.5	26.37	90000	K095x46	K105x54			
10	35.16	120000	K095x64	K105x84	K200xH32	K205x32	K215Dx34
12.5	43.95	150000			K200xH38	K205x40	
15	52.74	180000			K200xH46	K205x48	K215Dx46
20	70.32	240000			K200xH60	K205x64	K215Dx62
25	87.90	300000				K205x84	K215Dx78
30	105.48	360000				K205x108	K215Dx94
40	140.64	480000				K205x180	K215Dx126

The above information is for reference only; the data will be different under various working conditions and specifications.

## Model Selection Chart

### R407C vs. Water Condenser

Based on ARI-450 Standard

RT	kW	BTU/H	K025	K030	K040	K050	K060	K070
0.2	0.70	2400	K025x12	K030x12				
0.5	1.76	6000	K025x26	K030x26	K040x14			
1	3.52	12000	K025x44	K030x44	K040x24	K050x20	K060xH18	K070x18
1.5	5.27	18000			K040x32	K050x30	K060xH26	K070x28
2	7.03	24000			K040x42	K050x38	K060xH34	K070x36
2.5	8.79	30000				K050x50	K060xH44	K070x48
3	10.55	36000				K050x60	K060xH54	K070x58
4	14.06	48000				K050x76	K060xH68	K070x74

### R407C vs. Water Condenser

Based on ARI-450 Standard

RT	kW	BTU/H	K095	K105	K200	K205	K215D
2	7.03	24000	K095x18	K105x18			
2.5	8.79	30000	K095x20	K105x20			
3	10.55	36000	K095x26	K105x28			
4	14.06	48000	K095x36	K105x38			
5	17.58	60000	K095x44	K105x48			
7.5	26.37	90000	K095x66	K105x72	K200xH36	K205x34	
10	35.16	120000	K095x88	K105x96	K200xH46	K205x42	K215Dx42
12.5	43.95	150000			K200xH58	K205x54	
15	52.74	180000			K200xH70	K205x64	K215Dx66
20	70.32	240000			K200xH94	K205x86	K215Dx82
25	87.90	300000			K200xH118	K205x108	K215Dx106
30	105.48	360000			K200xH140	K205x128	K215Dx126
40	140.64	480000				K205x176	K215Dx170

### R407C vs. Water Evaporator

Based on ARI-480 Standard

RT	kW	BTU/H	K025	K030	K040	K050	K060	K070
0.2	0.70	2400	K025x10	K030x10				
0.5	1.76	6000	K025x16	K030x16	K040x10			
1	3.52	12000	K025x28	K030x28	K040x14	K050x10	K060xM10	K070x10
1.5	5.27	18000			K040x20	K050x14	K060xM14	K070x14
2	7.03	24000			K040x26	K050x16	K060xM16	K070x16
2.5	8.79	30000				K050x18	K060xM18	K070x18
3	10.55	36000				K050x22	K060xM22	K070x22
4	14.06	48000				K050x28	K060xM30	K070x28
5	17.58	60000				K050x36	K060xM40	K070x36

### R407C vs. Water Evaporator

Based on ARI-480 Standard

RT	kW	BTU/H	K095	K105	K200	K205	K215D
4	14.06	48000	K095x20	K105x18			
5	17.58	60000	K095x24	K105x22			
7.5	26.37	90000	K095x38	K105x38			
10	35.16	120000	K095x50	K105x50			K215Dx22
12.5	43.95	150000			K200xH28	K205x28	
15	52.74	180000			K200xH34	K205x34	K215Dx30
20	70.32	240000			K200xH44	K205x44	K215Dx42
25	87.90	300000			K200xH56	K205x58	K215Dx54
30	105.48	360000				K205x72	K215Dx66
40	140.64	480000				K205x110	K215Dx86

The above information is for reference only; the data will be different under various working conditions and specifications.

# Model Selection Chart

## R404A vs. Water Condenser

Based on ARI-450 Standard

RT	kW	BTU/H	K025	K030	K040	K050	K060	K070
0.2	0.70	2400	K025x10	K030x10				
0.5	1.76	6000	K025x18	K030x18	K040x10			
1	3.52	12000	K025x32	K030x32	K040x16	K050x16	K060xH12	K070x14
1.5	5.27	18000			K040x22	K050x22	K060xH18	K070x20
2	7.03	24000			K040x28	K050x28	K060xH22	K070x26
2.5	8.79	30000				K050x34	K060xH26	K070x32
3	10.55	36000				K050x40	K060xH30	K070x38
4	14.06	48000				K050x54	K060xH40	K070x52
5	17.58	60000				K050x66	K060xH50	K070x64

## R404A vs. Water Condenser

Based on ARI-450 Standard

RT	kW	BTU/H	K095	K105	K200	K205	K215D
4	14.06	48000	K095x24	K105x24			
5	17.58	60000	K095x28	K105x30			
7.5	26.37	90000	K095x42	K105x44			
10	35.16	120000	K095x56	K105x58	K200xH30	K205x28	K215Dx26
12.5	43.95	150000	K095x70	K105x72	K200xH38	K205x34	
15	52.74	180000			K200xH48	K205x42	K215Dx42
20	70.32	240000			K200xH62	K205x54	K215Dx54
25	87.9	300000			K200xH78	K205x68	K215Dx66
30	105.48	360000			K200xH94	K205x82	K215Dx82
40	140.64	480000			K200xH124	K205x110	K215Dx110
50	175.8	600000			K200xH154	K205x140	K215Dx138

## R404A vs. Water Evaporator

Based on ARI-480 Standard

RT	kW	BTU/H	K025	K030	K040	K050	K060	K070
0.2	0.70	2400	K025x12	K030x12				
0.5	1.76	6000	K025x24	K030x24	K040x12			
1	3.52	12000	K025x46	K030x46	K040x22	K050x14	K060xH12	K070x14
1.5	5.27	18000			K040x32	K050x20	K060xH16	K070x18
2	7.03	24000			K040x40	K050x26	K060xH20	K070x24
2.5	8.79	30000				K050x34	K060xH24	K070x32
3	10.55	36000				K050x44	K060xH30	K070x40
4	14.06	48000				K050x56	K060xH38	K070x52
5	17.58	60000				K050x70	K060xH48	K070x64

## R404A vs. Water Evaporator

Based on ARI-480 Standard

RT	kW	BTU/H	K095	K105	K200	K205	K215D
2.5	8.79	30000	K095x14	K105x16			
3	10.55	36000	K095x16	K105x18			
4	14.06	48000	K095x20	K105x24			
5	17.58	60000	K095x26	K105x30			
7.5	26.37	90000	K095x40	K105x46			
10	35.16	120000	K095x54	K105x62	K200xH30	K205x26	K215Dx26
12.5	43.95	150000	K095x70	K105x80	K200xH36	K205x32	
15	52.74	180000			K200xH42	K205x38	K215Dx38
20	70.32	240000			K200xH54	K205x50	K215Dx50
25	87.9	300000			K200xH68	K205x62	K215Dx62
30	105.48	360000			K200xH82	K205x76	K215Dx74
40	140.64	480000			K200xH114	K205x108	K215Dx106

The above information is for reference only; the data will be different under various working conditions and specifications.

# R Series-High Heat Transfer Performance Brazed Plate Heat Exchanger



R Series high heat transfer BPHE is designed with micro channel pattern, it is specially designed for high enthalpy refrigerant. This makes R series to perform better than K series. Compact design also reduce the thickness, weight and internal volume of the BPHE, making the installation easier.

Applicable refrigerants: R32, R290, R445B, R410A new generation eco-friendly refrigerants.

Main Application: Heat pump, chiller and HVAC system.

Brazing Material	Copper	Copper (Extra Strength)
Model	R020, R040, R050, R095, R200, R215	R021, R041, R051, R096, R201, R216
	(A1,A2/B1,B2)	
Max. Working Pressure (bar)	30/30	45/30
Max. Working Temperature (°C)	200°C	

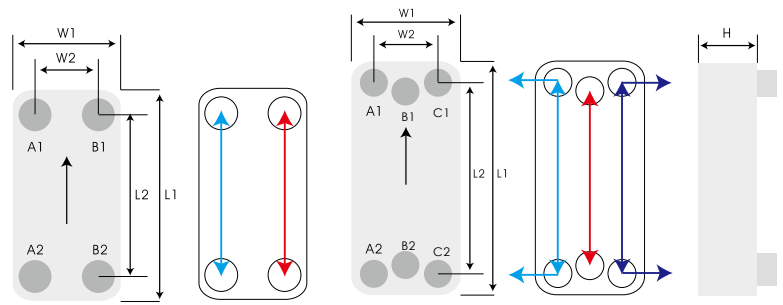

R215D/R216D: Dual Circuits- 6 Connections

Model	L1 (mm)	L2 (mm)	W1 (mm)	W2 (mm)	H Thickness (mm)	Weight*(kg) (Without Connection)	Volume/Channel (liter)	Total Volume (liter)
R020	191	154	77	40	7.0+1.15*N	0.62+0.042*N	0.009	(N-1)*0.009
R040	311	278	73	40	7.5+1.30*N	0.63+0.070*N	0.017	(N-1)*0.017
R050	306	250	106	50	9.3+1.80*N	1.20+0.089*N	0.038	(N-1)*0.038
R095	522	466	106	50	10.0+1.85*N	2.75+0.152*N	0.076	(N-1)*0.076
R200	613	519	186	92	14.0+2.05*N	6.94+0.385*N	0.175	(N-1)*0.175
R215	529	449	247	167	14.0+1.85*N	7.92+0.430*N	0.187	(N-1)*0.187

Model	L1 (mm)	L2 (mm)	W1 (mm)	W2 (mm)	H Thickness (mm)	Weight*(kg) (Without Connection)	Volume/Channel (liter)	Total Volume (liter)
R021	191	154	77	40	7.0+1.15*N	0.62+0.042*N	0.009	(N-1)*0.009
R041	311	278	73	40	7.5+1.30*N	0.63+0.070*N	0.017	(N-1)*0.017
R051	306	250	106	50	11.3+1.80*N	2.22+0.089*N	0.038	(N-1)*0.038
R096	522	466	106	50	10.0+1.85*N	2.83+0.154*N	0.076	(N-1)*0.076
R201	613	519	186	92	17.0+2.05*N	11.83+0.385*N	0.175	(N-1)*0.175
R216	529	449	247	167	17.0+1.85*N	13.51+0.430*N	0.187	(N-1)*0.187

N: number of plates

## Model Selection Chart

R290 vs. Water Condenser

Based on ARI-450 Standard

RT	kW	BTU/H	R020	R040	R050	R095
0.2	0.7	2400	R020Hx8			
0.5	1.76	6000	R020Hx14			
1	3.52	12000	R020Hx22		R050x10	
1.5	5.27	18000	R020Hx32	R040x18	R050x14	
2	7.03	24000	R020Hx42	R040x24	R050x18	
2.5	8.79	30000		R040x30	R050x22	

RT	kW	BTU/H	R020	R040	R050	R095
3	10.55	36000		R040x38	R050x26	
4	14.06	48000			R050x34	R095Mx20
5	17.58	60000			R050x42	R095Mx24
7.5	26.37	90000			R050x60	R095Mx36
10	35.16	120000			R050x80	R095Mx46
12.5	43.95	150000				R095Mx58
15	52.74	180000				R095Mx70



# Model Selection Chart

**R410A vs. Water Condenser** Based on ARI-450 Standard

RT	kW	BTU/H	R021	R051	R096	R201
0.2	0.7	2400	R021xH6			
0.5	1.76	6000	R021xH12			
1	3.52	12000	R021xH22	R051x10		
1.5	5.27	18000	R021xH32	R051x14		
2	7.03	24000	R021xH42	R051x16		
2.5	8.79	30000	R021xH52	R051x20		
3	10.55	36000		R051x24		
4	14.06	48000		R051x30	R096xM18	
5	17.58	60000		R051x38	R096xM24	
7.5	26.37	90000		R051x56	R096xM34	
10	35.16	120000		R051x74	R096xM46	R201x24
12.5	43.95	150000			R096xM58	R201x30
15	52.74	180000			R096xM72	R201x36
20	70.32	240000			R096xM100	R201x48
25	87.90	300000				R201x60
30	105.8	360000				R201x74
40	140.64	480000				R201x106
50	175.80	600000				R201x150

**R410A vs. Water Evaporator** Based on ARI-480 Standard

RT	kW	BTU/H	R020	R050	R095	R200
0.2	0.7	2400	R020xH8			
0.5	1.76	6000	R020xH16			
1	3.52	12000	R020xH26	R050x10		
1.5	5.27	18000	R020xH38	R050x14		
2	7.03	24000	R020xH50	R050x18		
3	10.55	36000		R050x20		
4	14.06	48000		R050x24	R095xM20	
5	17.58	60000		R050x32	R095xM24	
7.5	26.37	90000		R050x40	R095xM36	
10	35.16	120000		R050x62	R095xM48	R200x24
12.5	43.95	150000		R050x90	R095xM62	R200x30
15	52.74	180000			R095xM76	R200x36
20	70.32	240000			R095xM108	R200x48
25	87.90	300000				R200x60
30	105.8	360000				R200x74
40	140.64	480000				R200x106
50	175.80	600000				R200x150

**R134a vs. Water Condenser** Based on ARI-450 Standard

RT	kW	BTU/H	R020	R050	R095	R200
0.2	0.7	2400	R020xH6			
0.5	1.76	6000	R020xH14			
1	3.52	12000	R020xH26	R050x12		
1.5	5.27	18000	R020xH38	R050x18		
2	7.03	24000	R020xH50	R050x22		
2.5	8.79	30000		R050x28		
3	10.55	36000		R050x34	R095xH14	
4	14.06	48000		R050x44	R095xH20	
5	17.58	60000		R050x54	R095xH24	
7.5	26.37	90000		R050x80	R095xH36	
10	35.16	120000			R095xH50	R200x24
12.5	43.95	150000			R095xH64	R200x30
15	52.74	180000			R095xH80	R200x36
20	70.32	240000				R200x48
25	87.90	300000				R200x60
30	105.48	360000				R200x74
40	140.64	480000				R200x106
50	175.80	600000				R200x150

**R134a vs. Water Evaporator** Based on ARI-480 Standard

RT	kW	BTU/H	R020	R050	R095	R200
0.2	0.7	2400	R020xH8			
0.5	1.76	6000	R020xH16			
1	3.52	12000	R020xH26	R050x12		
1.5	5.27	18000	R020xH38	R050x16		
2	7.03	24000	R020xH50	R050x20		
2.5	8.79	30000		R050x24		
3	10.55	36000		R050x30	R095xH18	
4	14.06	48000		R050x38	R095xH22	
5	17.58	60000		R050x50	R095xH28	
7.5	26.37	90000		R050x76	R095xH44	
10	35.16	120000			R095xH60	R200x30
12.5	43.95	150000			R095xH80	R200x36
15	52.74	180000			R095xH110	R200x44
20	70.32	240000				R200x58
25	87.90	300000				R200x74
30	105.48	360000				R200x88
40	140.64	480000				R200x120
50	175.80	600000				R200x160

**R32 vs. Water Condenser** Based on ARI-450 Standard

RT	kW	BTU/H	R021	R051	R096	R201
0.2	0.7	2400	R021xH6			
0.5	1.76	6000	R021xH10			
1	3.52	12000	R021xH18	R051x10		
1.5	5.27	18000	R021xH26	R051x12		
2	7.03	24000	R021xH36	R051x14		
2.5	8.79	30000	R021xH44	R051x18		
3	10.55	36000		R051x20		
4	14.06	48000		R051x26	R096xM16	
5	17.58	60000		R051x32	R096xM20	
7.5	26.37	90000		R051x48	R096xM30	
10	35.16	120000		R051x64	R096xM40	R201x24
12.5	43.95	150000			R096xM50	R201x30
15	52.74	180000			R096xM62	R201x36
20	70.32	240000			R096xM86	R201x48
25	87.90	300000				R201x60
30	105.48	360000				R201x74
40	140.64	480000				R201x106
50	175.80	600000				R201x150

**R32 vs. Water Evaporator** Based on ARI-480 Standard

RT	kW	BTU/H	R020	R050	R095	R200
0.2	0.7	2400	R020xH10			
0.5	1.76	6000	R020xH18			
1	3.52	12000	R020xH30	R050x10		
1.5	5.27	18000	R020xH42	R050x14		
2	7.03	24000	R020xH54	R050x18		
2.5	8.79	30000		R050x22		
3	10.55	36000		R050x26		
4	14.06	48000		R050x36	R095xH22	
5	17.58	60000		R050x48	R095xH26	
7.5	26.37	90000		R050x72	R095xH38	
10	35.16	120000		R050x102	R095xH52	R200x24
12.5	43.95	150000			R095xH66	R200x30
15	52.74	180000			R095xH80	R200x36
20	70.32	240000			R095xH112	R200x48
25	87.90	300000				R200x60
30	105.48	360000				R200x74
40	140.64	480000				R200x106
50	175.80	600000				R200x150

The above information is for reference only; the data will be different under various working conditions and specifications.

# Z Series-Large Diagonal Flow Brazed Plate Heat Exchanger



The newly innovative Z series is designed with a diagonal flow pattern, providing higher efficiency to replace traditional shell and tube, double tube or multi-tube heat exchangers in various applications. The advantage of Z series dual circuits is to provide the best performance in both full load and part load conditions. Z series single circuit is specially designed for large flow rate meeting high heat transfer efficiency requirement.

**Main Application:**  
Refrigeration, Process Cooling, ORC

**Z140/300/400/401/600/601:**  
Single Circuit, 4 Connections.

**Z085D/086D/415/416:**  
Dual Circuits, 6 Connections.

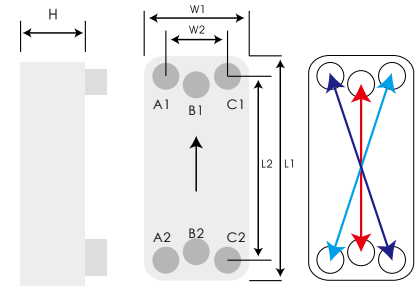

**Z085D/086D/415/416**

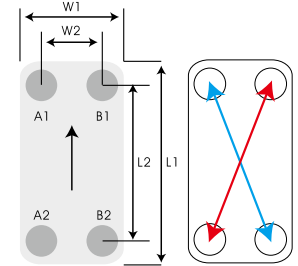

**Z140/300/400/401/600/601**

Brazing Material	Copper			Copper(Extra Strength)	
Model	Z140, Z300	Z400, Z600	Z085D, Z415	Z401, Z601	Z086D, Z416
	(A2,B1/A1,B2)		(A2,C1/A1,C2/B1,B2)	(A2,B1/A1,B2)	(A2,C1/A1,C2/B1,B2)
Max. Working Pressure (bar)	20/20	30/30	30/30/30	45/30	45/45/30
Max. Working Temperature (°C)	200°C				

\* For nickel brazing requirement of Z Series, please contact KAORI representative.

Model	L1 (mm)	L2 (mm)	W1 (mm)	W2 (mm)	H Thickness (mm)	Weight*(kg) (Without Connection)	Volume/ Channel (liter)	Total Volume (liter)
Z085D	307	244	190	127	10.0+1.55*N	3.29+0.18*N	(A1-C2): 0.0685 (A2-C1): 0.0685 (B1-B2): 0.0486	(A1-C2): (N-1)*0.0685 (A2-C1): (N-1)*0.0685 (B1-B2): (N-1)*0.0486
Z140	440	360	205	125	10.3+2.28*N	4.29+0.24*N	0.176	(N-1)*0.176
Z300	651	520	321	190	17.0+2.38*N	20.89+0.80*N	0.360	(N-1)*0.360
Z400	751	650	321	220	14.0+2.38*N	30.02+0.89*N	0.423	(N-1)*0.423
Z415	751	656	321	226	14.0+2.40*N	29.78+0.87*N	0.414	(N-1)*0.414
Z600	945	810	375	240	14.0+2.38*N	52.99+1.23*N	0.620	(N-1)*0.620

Model	L1 (mm)	L2 (mm)	W1 (mm)	W2 (mm)	H Thickness (mm)	Weight*(kg) (Without Connection)	Volume/ Channel (liter)	Total Volume (liter)
Z086D	307	244	190	127	10.0+1.55*N	3.29+0.18*N	(A1-C2): 0.0685 (A2-C1): 0.0685 (B1-B2): 0.0486	(A1-C2): (N-1)*0.0685 (A2-C1): (N-1)*0.0685 (B1-B2): (N-1)*0.0486
Z401	751	650	321	220	23.0+2.38*N	36.54+0.89*N	0.423	(N-1)*0.423
Z416	751	656	321	226	23.0+2.40*N	36.26+0.87*N	0.414	(N-1)*0.414
Z601	945	810	375	240	36.0+2.38*N	53.31+1.23*N	0.620	(N-1)*0.620

N: number of plates

## Model Selection Chart

### R134a vs. Water Condenser

Based on ARI-450 Standard

RT	kW	kBTU/H	Z400	Z415	Z600
40	140.64	480	Z400xM58	Z415x58	
50	175.80	600	Z400xM72	Z415x74	
60	210.96	720	Z400xM84	Z415x86	
75	263.70	900	Z400xM106	Z415x106	
100	351.60	1200	Z400xM140	Z415x142	Z600xM124
125	439.50	1500	Z400xM176	Z415x178	Z600xM156
150	527.40	1800			Z600xM190

### R134a vs. Water Evaporator

Based on ARI-480 Standard

RT	kW	kBTU/H	Z400	Z415	Z600
40	140.64	480	Z400xH64	Z415x66	
50	175.80	600	Z400xH80	Z415x82	
60	210.96	720	Z400xH98	Z415x98	
75	263.70	900	Z400xH126	Z415x126	
100	351.60	1200	Z400xH170	Z415x170	Z600xH152
125	439.50	1500	Z400xH220	Z415x222	Z600xH196
150	527.40	1800			Z600xH240

### R407C vs. Water Condenser

Based on ARI-450 Standard

RT	kW	kBTU/H	Z400	Z415	Z600
40	140.64	480	Z400xH82	Z415x82	
50	175.80	600	Z400xH102	Z415x102	
60	210.96	720	Z400xH122	Z415x122	
75	263.70	900	Z400xH152	Z415x154	
100	351.60	1200	Z400xH206	Z415x206	Z600xH144
125	439.50	1500			Z600xH180
150	527.40	1800			Z600xH218

### R407C vs. Water Evaporator

Based on ARI-480 Standard

RT	kW	kBTU/H	Z400	Z415	Z600
40	140.64	480	Z400xM50	Z415x50	
50	175.80	600	Z400xM62	Z415x62	
60	210.96	720	Z400xM76	Z415x78	
75	263.70	900	Z400xM96	Z415x98	
100	351.60	1200	Z400xM130	Z415x130	Z600xM106
125	439.50	1500	Z400xM172	Z415x174	Z600xM140
150	527.40	1800			Z600xM180

### R410A vs. Water Condenser

Based on ARI-450 Standard

RT	kW	kBTU/H	Z401	Z416	Z601
40	140.64	480	Z401xM48	Z416x50	
50	175.80	600	Z401xM60	Z416x62	
60	210.96	720	Z401xM72	Z416x74	
75	263.70	900	Z401xM90	Z416x90	
100	351.60	1200	Z401xM120	Z416x126	Z601xM72
125	439.50	1500	Z401xM150	Z416x162	Z601xM90
150	527.40	1800			Z601xM110
175	615.30	2100			Z601xM128
200	703.20	2400			Z601xM146
225	791.10	2700			Z601xM164

### R410A vs. Water Evaporator

Based on ARI-480 Standard

RT	kW	kBTU/H	Z400	Z415	Z600
40	140.64	480	Z400xH50	Z415x50	
50	175.80	600	Z400xH62	Z415x62	
60	210.96	720	Z400xH76	Z415x78	
75	263.70	900	Z400xH96	Z415x98	
100	351.60	1200	Z400xH130	Z415x130	Z600xM126
125	439.50	1500	Z400xH172	Z415x174	Z600xM160
150	527.40	1800			Z600xM200

The above information is for reference only; the data will be different under various working conditions and specifications.

Let's **SAVE** the world together



High Quality from **Ta**wan

# C Series-CO<sub>2</sub> Super High Pressure Brazed Plate Heat Exchanger



KAORI patented solution with C series is specially designed for Gas cooler, condenser, evaporator and economizer in R744 (CO<sub>2</sub>) heat pump and refrigeration system. Different designs with max. working pressure 140 bar, 100 bar and 70 bar are available for Supercritical, Transcritical and Subcritical CO<sub>2</sub> heating and cooling systems.

Compact size, outstanding heat transfer performance and low pressure drop are the three key features. The quality and the durability of C series is proven by thorough inspection, achieving the burst test pressure up to 650 bar and cycle test over 100,000 cycles.

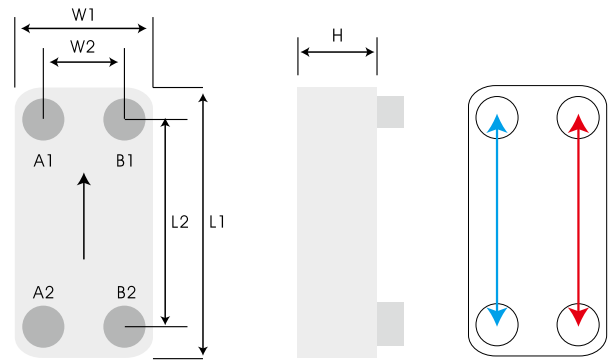

Brazing Material	Copper		
Model	C020,C040 C095,C200	C021,C041 C096,C201	C022,C042 C097,C202
	(A1,A2/B1,B2)		
Max. Working Pressure (bar)	70/30*	100/30*	140/30*
Max. Working Temperature (°C)	200°C		

\* For higher working pressure request on B1/B2, please contact KAORI representative.

Model	L1 (mm)	L2 (mm)	W1 (mm)	W2 (mm)	H Thickness (mm)	Weight*(kg) (Without Connection)	Volume/Channel (liter)	Total Volume (liter)
C020	191	154	77	40	9.5+1.10*N	1.12+0.042*N	0.009	(N-1)*0.009
C040	314	275	76	40	13.0+2.00*N	1.74+0.145*N	0.030	(N-1)*0.030
C095	524	466	108	50	13.2+2.16*N	5.52+0.320*N	0.071	(N-1)*0.071
C200	616	519	189	92	14.0+2.15*N	12.39+0.603*N	0.156	(N-1)*0.156

Model	L1 (mm)	L2 (mm)	W1 (mm)	W2 (mm)	H Thickness (mm)	Weight*(kg) (Without Connection)	Volume/Channel (liter)	Total Volume (liter)
C021	191	154	77	40	9.5+1.10*N	1.14+0.042*N	0.009	(N-3)*0.009
C041	314	275	76	40	13.0+2.00*N	1.83+0.145*N	0.030	(N-1)*0.030
C096	524	466	108	50	13.2+2.16*N	5.68+0.320*N	0.071	(N-1)*0.071
C201	616	519	189	92	14.0+2.15*N	12.56+0.631*N	0.156	(N-1)*0.156

Model	L1 (mm)	L2 (mm)	W1 (mm)	W2 (mm)	H Thickness (mm)	Weight*(kg) (Without Connection)	Volume/Channel (liter)	Total Volume (liter)
C022	191	154	77	40	9.5+1.10*N	1.13+0.042*N	0.009	(N-5)*0.009
C042	314	275	76	40	13.0+2.00*N	1.75+0.152*N	0.030	(N-1)*0.030
C097	524	466	108	50	13.2+2.16*N	5.90+0.346*N	0.071	(N-1)*0.071
C202	616	519	189	92	14.0+2.15*N	12.41+0.755*N	0.156	(N-1)*0.156

N: number of plates

# Model Selection Chart

R744 vs. Water Gas Cooler (Max. Working Pressure : 140bar)

RT	kW	BTU/H	C020/C021/C022	C040/C041/C042	C095/C096/C097	C200/C201/C202
1	3.52	12000	C022xH36 (4 Pass)	C042x24 (4 Pass)		
1.5	5.27	18000	C022xH44 (4 Pass)	C042x32 (4 Pass)		
2	7.03	24000	C022xH52 (4 Pass)	C042x40 (4 Pass)		
3	10.55	36000			C097x24 (4 Pass)	
4	14.06	48000			C097x32 (4 Pass)	
5	17.58	60000			C097x40 (4 Pass)	C202xH24 (3 Pass)
7.5	26.37	90000			C097x48 (4 Pass)	C202xH30 (3 Pass)
10	35.16	120000			C097x64 (4 Pass)	C202xH36 (3 Pass)
12.5	43.95	150000			C097x72 (4 Pass)	C202xH48 (3 Pass)
15	52.74	180000			C097x88 (4 Pass)	C202xH54 (3 Pass)
20	70.32	240000				C202xH66 (3 Pass)
25	87.90	300000				C202xH84 (3 Pass)
30	105.48	360000				C202xH102 (3 Pass)
35	123.06	420000				C202xH114 (3 Pass)
40	140.64	480000				C202xH132 (3 Pass)

The above information is for reference only; the data will be different under various working conditions and specifications.

## CO<sub>2</sub> Heat Pump System

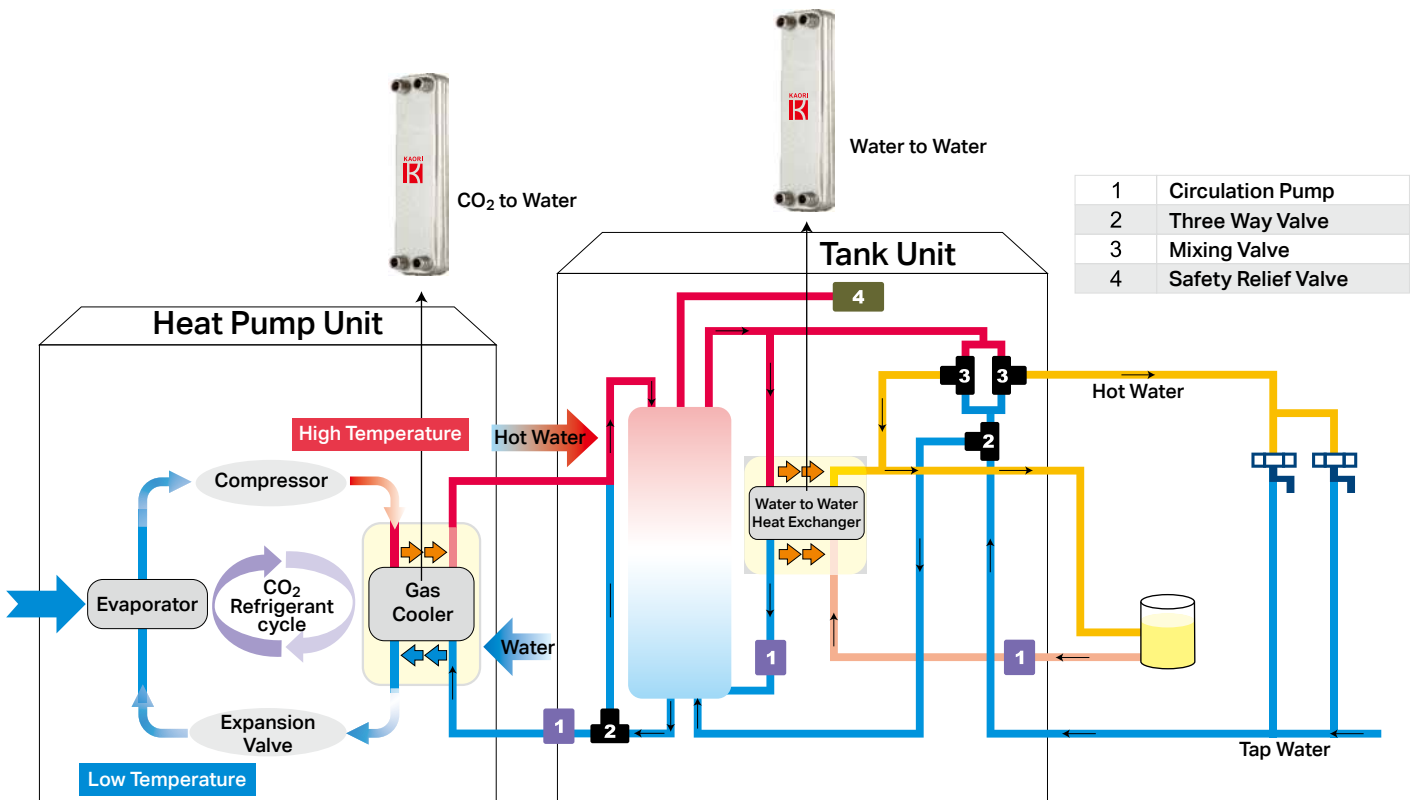

# B Series-Asymmetric Brazed Plate Heat Exchanger



The new KAORI B Series delivers an effective operating range up to 100kW for heat pumps, heating, cooling and refrigeration systems with efficiency and reliability benefits.

The B Series design effectively helps to lower pressure drop by 25%, reduce refrigerant filling volume by 44%, increase water flow rate by 19% and cut the weight by up to 48%, these overcome common impact on water-side pressure drop while maximizing system performance, energy efficiency and reliability.

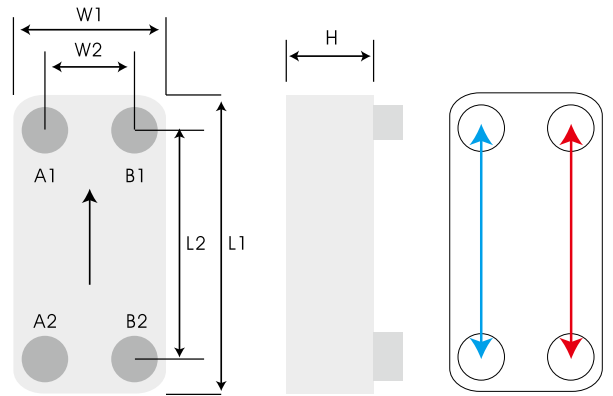

Brazing Material	Copper	
Model	B050, B075, B110	B051, B076, B081, B111
	(A1,A2/B1,B2)	
Max. Working Pressure (bar)	32/25	45/30
Max. Working Temperature (°C)	200°C	

Model	L1 (mm)	L2 (mm)	W1 (mm)	W2 (mm)	H Thickness (mm)	Weight*(kg) (Without Connection)	Volume/ Channel (liter)	Total Volume (liter)
B050	309	250	109	50	10.5+1.80*N	1.20+0.089*N	(A1-A2):0.031 (B1-B2):0.046	(N/2-1)*0.031 (N/2)*0.046
B075	330	279	119	68	9.4+1.50*N	1.52+0.111*N	(A1-A2):0.038 (B1-B2):0.047	(N/2-1)*0.038 (N-1)*0.047
B110	529	470	122	63	10.5+1.85*N	2.27+0.170*N	(A1-A2):0.068 (B1-B2):0.098	(N/2-1)*0.068 (N-1)*0.098

Model	L1 (mm)	L2 (mm)	W1 (mm)	W2 (mm)	H Thickness (mm)	Weight*(kg) (Without Connection)	Volume/ Channel (liter)	Total Volume (liter)
B051	309	250	109	50	12.5+1.80*N	2.14+0.089*N	(A1-A2):0.031 (B1-B2):0.046	(N/2-1)*0.031 (N-1)*0.046
B076	330	279	119	68	9.4+1.50*N	1.52+0.111*N	(A1-A2):0.038 (B1-B2):0.047	(N/2-1)*0.038 (N-1)*0.047
B081	377	329	120	72	9.4+1.70*N	1.68+0.124*N	(A1-A2):0.050 (B1-B2):0.062	(N/2-1)*0.050 (N-1)*0.062
B111	529	470	122	63	12.5+1.85*N	4.13+0.170*N	(A1-A2):0.068 (B1-B2):0.098	(N/2-1)*0.068 (N-1)*0.098

N: number of plates

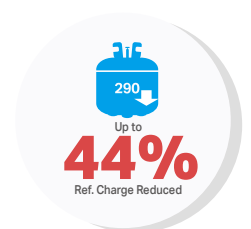
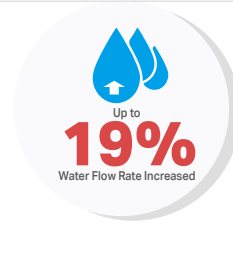
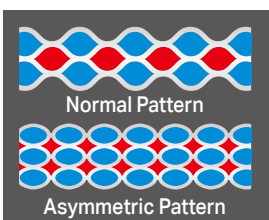

# A Series-Air Dryer Brazed Plate Heat Exchanger



A series is KAORI's innovative patent design for refrigerated air dryer. Combining pre-cooler, evaporator and separator. A series provides compact size and high thermal transfer performance for your system. The patented design separator can perfectly dehumidify compressed air and eliminate the need for demister to avoid clogging problem.

Brazing Material	Copper	
Model	A030, A070, A140	A210, A300
	(A2,B1/C2,D2)	
Max. Working Pressure (bar)	30/ 16	30/10
Max. Working Temperature (°C)	200°C	

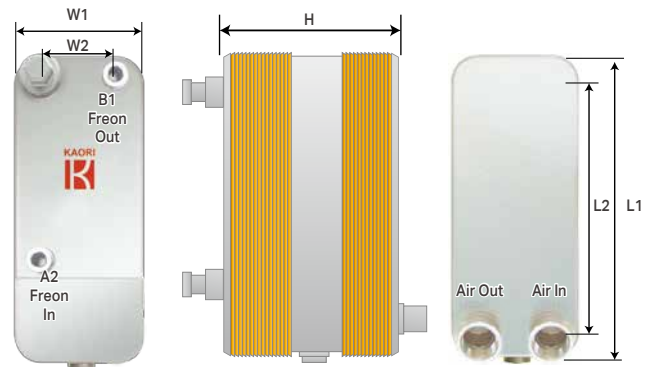

Model	Air Flow Rate @7bar			L1 (mm)	L2 (mm)	W1 (mm)	W2 (mm)	Weight (kg)	H Thickness (mm)	Recommend Air Connection (inch)
	Nm <sup>3</sup> /min	Nm <sup>3</sup> /hr	sCFM							
A030-14-8	0.58	34.8	20.57	192	154	78	40	2.94	97.0	3/4"
A030-20-10	0.83	49.8	29.43	192	154	78	40	3.27	114.0	3/4"
A030-22-12	1.00	60.0	35.46	192	154	78	40	3.44	122.0	3/4"
A030-24-16	1.33	79.8	47.16	192	154	78	40	4.57	135.0	3/4"
A030-40-24	1.67	100.2	59.22	192	154	78	40	4.73	185.0	3/4"
A070-20-26	2.40	144.0	85.11	304	250	124	70	11.2	158.3	1"
A070-32-40	4.20	252.0	148.94	304	250	124	70	14.9	232.7	1-1/4"
A070-46-66	7.00	420.0	248.23	304	250	124	70	21.3	356.6	1-1/2"
A140-24-36	11.00	660.0	390.07	441	360	206	125	30.7	227.9	2"
A140-32-44	14.00	840.0	496.45	441	360	206	125	36.2	284.7	2"
A210-40-50	22.00	1320.0	780.14	527	430	245	148	77.6	394.4	2-1/2"
A210-50-64	28.00	1680.0	992.91	527	430	245	148	95.9	501.0	3"
A300-41-46	35.00	2100.0	1235.5	651	520	321	190	138.4	472.0	4"
A300-47-54	40.00	2400.0	1412.0	651	520	321	190	147.4	505.0	4"
A300-55-60	45.00	2700.0	1588.5	651	520	321	190	156.0	538.0	4"
A300-61-70	50.00	3000.0	1765.5	651	520	321	190	166.4	576.0	4"

E.g. A030-14-8, 14 is the number of plates of the evaporator on air-freon side, 8 is the number of plates of the pre-cooler on air-air side.

\* The flow direction might be changed according to different models, please refer to the drawing and user manual for detail.

\* This table only lists the standard A series products. If there is a selection requirement of special type A series, please refer to the KAORI A series catalogue.

# D Series-Double Wall Brazed Plate Heat Exchanger



To prevent two different kinds of fluid from intermixing caused by internal leakage, KAORI precisely designed D Series solution with the double-stacked plates, eliminating the possibility of cross contamination.

The unique air gap is created between the two plates. Once internal leakage occurs, the 2nd plate becomes a shield to keep fluid stay and flow on the same channel through the air gap. Meanwhile, vent holes outside the plate will seep out fluid as an indication of leakage.

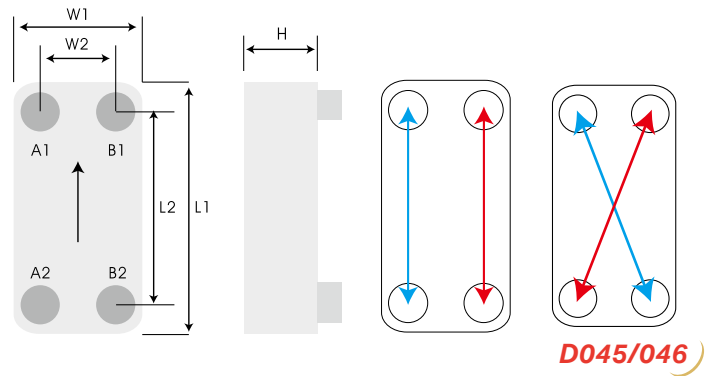

Brazing Material	Copper	
Model	D030, D045, D070	D031, D046, D071, D206
	(A1, A2/B1, B2)	
Max. Working Pressure (bar)	30/30	45/30
Max. Working Temperature (°C)	200°C	

Model	L1 (mm)	L2 (mm)	W1 (mm)	W2 (mm)	H Thickness (mm)	Weight*(kg) (Without Connection)	Volume/Channel (liter)	Total Volume (liter)
D030	202	156	92	46	8.0+2.40*N	0.45+0.104*N	0.027	(N-1)*0.027
D045*	363	320	82	40	8.3+2.02*N	1.00+0.166*N	0.030	(N-1)*0.030
D070	306	250	126	70	9.3+2.60*N	1.53+0.203*N	0.059	(N-1)*0.059

Model	L1 (mm)	L2 (mm)	W1 (mm)	W2 (mm)	H Thickness (mm)	Weight*(kg) (Without Connection)	Volume/Channel (liter)	Total Volume (liter)
D031	202	156	92	46	9.0+2.40*N	0.71+0.104*N	0.027	(N-1)*0.027
D046*	363	320	82	40	8.3+2.02*N	1.18+0.166*N	0.030	(N-1)*0.030
D071	306	250	126	70	11.3+2.60*N	2.65+0.218*N	0.059	(N-1)*0.059
D206	528	456	246	174	16.5+2.60*N	13.84+0.772*N	0.222	(N-1)*0.222

N: number of plates  
\* D045/ D046: diagonal design.

## Double Wall Vs. Regular BPHE

### KAORI Double Wall

The cracks on plates doesn't lead to internal leakage between fluids, which can be distinguished from outer appearance.

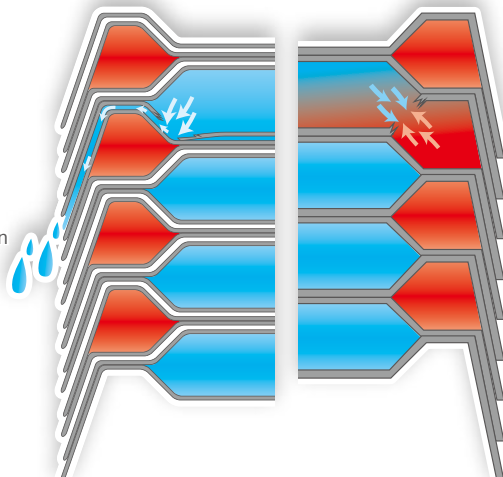

### Regular BPHE

The cracks on plates result in internal leakage between fluids, which can't be distinguished from outer surface



# E/F Series-Low Pressure Brazed Plate Heat Exchanger



E/ F series is designed for the specification of small volume water to water application. E series is flat cover plate design and F series is economical design (without flat cover plate); also, multi-pass pattern are available upon different working conditions and requests.

Main application: Residential Gas Boiler, District Heating, Solar Heating System.

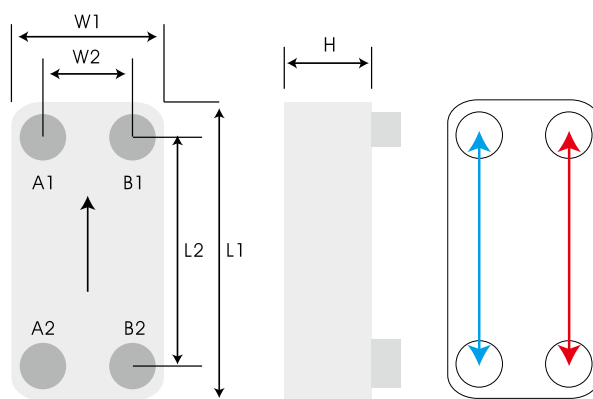

Brazing Material	Copper
Model	E010, E015, F015, E030, E040, E050, E060 (A1,A2/B1,B2)
Max. Working Pressure (bar)	20/20
Max. Working Temperature (°C)	200°C

Model	L1 (mm)	L2 (mm)	W1 (mm)	W2 (mm)	H Thickness (mm)	Weight*(kg) (Without Connection)	Volume/ Channel (liter)	Total Volume (liter)
E010	137	110	62	26	6.5+1.7*N	0.147+0.024*N	0.011	(N-1)*0.011
E015	155	120	75	40	9.0+1.80*N	0.21+0.036*N	0.016	(N-1)*0.016
F025	206	172	73	40/42	6.5+2.27*(N-2)	0.19+0.040*(N-2)	0.025	(N-1)*0.025
E030	195	154	80	40	7.0+2.25*N	0.29+0.047*N	0.025	(N-1)*0.025
E040	311	278	73	40	9.0+2.30*N	0.62+0.070*N	0.040	(N-1)*0.040
E050	306	250	106	50	9.0+2.38*N	1.15+0.116*N	0.055	(N-1)*0.055
E060	466	432	74	40	9.0+2.30*N	0.66+0.100*N	0.064	(N-1)*0.064

N: number of plates

## Model Selection Chart

RT	kW	BTU/H	Hot Water Temp.	Cold Water Temp.	E015	F025	E030	E040	E060
1	3.5160	12000	70°C --> 50°C	10°C --> 60°C	E015x14	F025x12	E030x12		
2	7.0320	24000	70°C --> 50°C	10°C --> 60°C	E015x18	F025x16	E030x16		
3	10.5480	36000	70°C --> 50°C	10°C --> 60°C	E015x26	F025x22	E030x22		
4	14.0640	48000	70°C --> 50°C	10°C --> 60°C	E015x30	F025x26	E030x26		
5	17.5800	60000	70°C --> 50°C	10°C --> 60°C		F025x32	E030x32	E040x10	
7.5	26.3700	90000	70°C --> 50°C	10°C --> 60°C		F025x44	E030x44	E040x14	E060xH10
10	35.1600	120000	70°C --> 50°C	10°C --> 60°C		F025x56	E030x56	E040x18	E060xH12
15	52.7400	180000	70°C --> 50°C	10°C --> 60°C				E040x26	E060xH18
20	70.3200	240000	70°C --> 50°C	10°C --> 60°C				E040x36	E060xH24
25	87.9000	300000	70°C --> 50°C	10°C --> 60°C				E040x50	E060xH30
30	105.480	360000	70°C --> 50°C	10°C --> 60°C					E060xH40

The above information is for reference only; the data will be different under various working conditions and specifications.

# Series-Impact Resistant Brazed Plate Heat Exchanger



I series is suitable for those applications with the possibilities of encountering thermal shocks or pressure shocks. The optimal heat transfer efficiency and pressure resistance that can withstand tough operation conditions like Hydraulic System, Injection Molding System and Boiler System.

Brazing Material	Copper	
Model	I030, I050, I070, I095, I105, I200, I205, I400	I210
	(A1,A2/B1,B2)	
Max. Working Pressure (bar)	30/30	16/16
Max. Working Temperature (°C)	200°C	

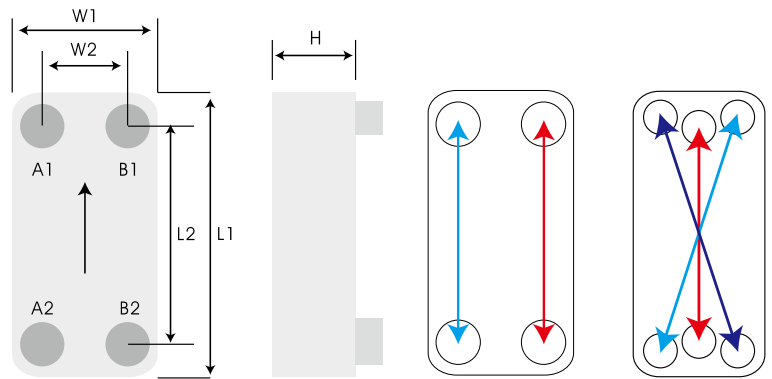

I400

Model	L1 (mm)	L2 (mm)	W1 (mm)	W2 (mm)	H Thickness (mm)	Weight*(kg) (Without Connection)	Volume/Channel (liter)	Total Volume (liter)
I030	194	154	80	40	10.0+2.20*N	0.59+0.047*N	0.025	(N-5)*0.025
I050	306	250	106	50	10.0+2.38*N	1.19+0.116*N	0.055	(N-5)*0.055
I070	304	250	124	70	10.0+2.38*N	1.46+0.131*N	0.065	(N-5)*0.065
I095	522	466	106	50	11.0+2.38*N	2.83+0.204*N	0.095	(N-5)*0.095
I105	504	444	124	64	11.0+2.38*N	3.44+0.237*N	0.107	(N-5)*0.107
I200	613	519	186	92	14.0+2.40*N	6.89+0.404*N	0.206	(N-5)*0.206
I205	528	456	246	174	14.0+2.40*N	7.51+0.438*N	0.232	(N-5)*0.232
I210	527	430	245	148	11.5+2.85*N	6.59+0.490*N	0.289	(N-5)*0.289
I400*	751	650	321	220	14.0+2.38*N	31.1+0.890*N	0.423	(N-5)*0.423

N: number of plates  
\*I400: diagonal design.

# Q Series-Oil Cooler Brazed Plate Heat Exchanger



The Q Series is excellent for both shell & tube replacement and hydraulic applications. Q series is set to increase cooling performance, significantly reduce downtime and increase production efficiency. Q series can save time and money for the amount of cooling water required for heat transfer which will result in lower operating costs and maintenance.

### Application:

Extruder, Injection Molding Machine, Gearbox, High Frequency Equipment, Press Machine, Lathe, Milling Machine And Punch.

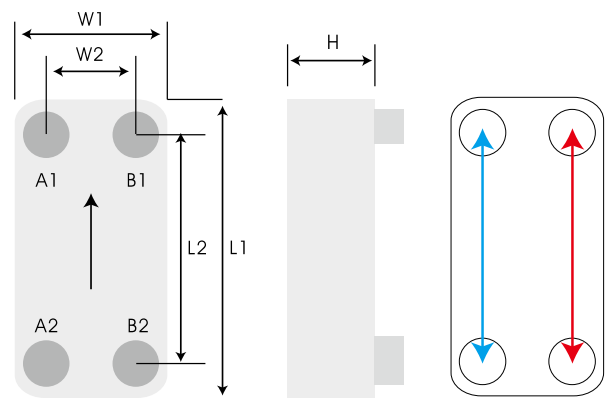

Brazing Material	Copper
Model	Q035, Q055, Q085 (A1, A2/B1, B2)
Max. Working Pressure (bar)	30/30
Max. Working Temperature (°C)	200°C

Model	L1 (mm)	L2 (mm)	W1 (mm)	W2 (mm)	H Thickness (mm)	Weight*(kg) (Without Connection)	Volume/Channel (liter)
Q035	186	143	126	83	9.0+2.38*N	1.02+0.084*N	0.0431
Q055	256	190	156	90	12.0+2.85*N	2.32+0.155*N	0.0832
Q085	302.4	240	189.4	127	11.0+2.40*N	2.62+0.199*N	0.1068

N: number of plates

## Model Selection Chart

Fuel Tank Capacity (Liter)	Applicable Models
60	Q035 x 20
100	Q035 x 30
150	Q085 x 22
250	Q085 x 42
350	Q085 x 66

## Applicable fluids

Water、E.G.、P.G.、ATF、  
SAE10~SAE70、VG22~VG68、  
R134a、R404A、R407C



Stud Bolts

## Heat Transfer Performance Comparison Q Series Vs. Shell & Tube

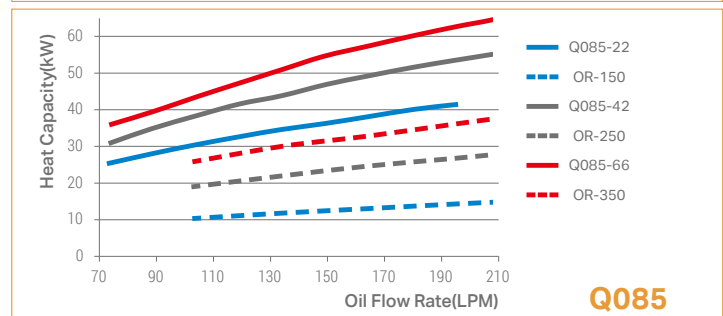
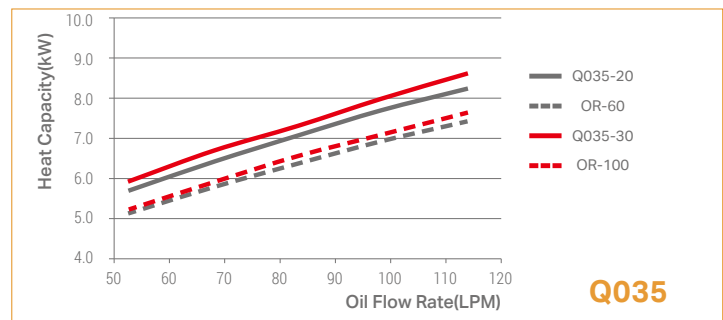

# H/T Series-High Temperature Brazed Plate Heat Exchanger



H series uses heat resistant materials to construct BPHE for high temperature applications, maximum working temperature can go up to 900°C. In green energy application such as fuel cells is using such high temperature BPHE for its heating and cooling.

T series processes lower pressure drop than H series, it is more suitable for low pressure gas.

Main application: Fuel cell, Cogeneration, combined heat and power, waste heat recovery.

Brazing Material	Nickel					
Model	H030, H050, H095, H205, T030, T035, T050, T085, T200, T210		H031, H051, H096, H206, T031, T051, T086, T201, T211		T032, T037, T052, T087, T202, T212	
	(A1, A2/B1, B2)					
Max. Working Pressure (bar)	10/10	7/7	3/3	2/2	10/10	10/10
Max. Working Temperature (°C)	0~650	~700	~800	~900	~550	200

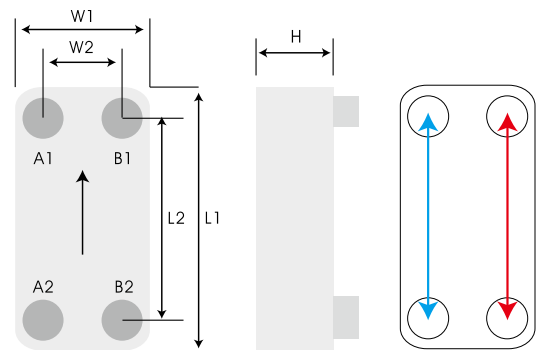

Model	L1 (mm)	L2 (mm)	W1 (mm)	W2 (mm)	H Thickness (mm)	Weight*(kg) (Without Connection)	Volume/Channel (liter)
H030	194	154	80	40	9.0+2.30*N	0.73+0.068*N	0.025
H031	194	154	80	40	9.0+2.30*N	0.69+0.064*N	0.025
H050	306	250	106	50	10.0+2.38*N	2.38+0.137*N	0.055
H051	306	250	106	50	10.0+2.38*N	2.25+0.129*N	0.055
H095	522	466	106	50	10.0+2.40*N	3.32+0.216*N	0.095
H096	522	466	106	50	10.0+2.40*N	3.15+0.204*N	0.095
H205	528	456	246	174	11.5+2.40*N	8.82+0.546*N	0.232
H206	528	456	246	174	11.5+2.40*N	8.69+0.566*N	0.232

Model	L1 (mm)	L2 (mm)	W1 (mm)	W2 (mm)	H Thickness (mm)	Weight*(kg) (Without Connection)	Volume/Channel (liter)
T030	194	154	80	40	9.0+2.30*N	0.73+0.068*N	0.025
T031/ T032	194	154	80	40	9.0+2.30*N	0.69+0.064*N	0.025
T035	186	143	126	83	9.0+2.38*N	1.02+0.089*N	0.043
T036/ T037	186	143	126	83	9.0+2.38*N	1.02+0.084*N	0.043
T050	306	250	106	50	10.0+2.38*N	2.38+0.137*N	0.055
T051/ T052	306	250	106	50	10.0+2.38*N	2.25+0.129*N	0.055
T085	302.4	240	189.4	77	11.0+2.40*N	2.62+0.210*N	0.107
T086/ T087	302.4	240	189.4	77	11.0+2.40*N	2.62+0.199*N	0.107
T200	613	519	186	92	14.0+2.40*N	6.89+0.427*N	0.206
T201/ T202	613	519	186	92	14.0+2.40*N	6.89+0.404*N	0.206
T210	527	430	245	148	11.5+2.85*N	6.68+0.492*N	0.289
T211/ T212	527	430	245	148	11.5+2.85*N	6.68+0.465*N	0.289

# M Series-Corrosion Resistant Brazed Plate Heat Exchanger



M series is specially designed for higher chlorine content applications.

M series is made of corrosion resistant stainless steel (equivalent to SMO254).

Brazing Material	Nickel
Model	M050, M095, M205
Plate Material	Equivalent to SMO254 (A1,A2/B1,B2)
Max. Working Pressure (bar)	10/10
Min. Test Pressure (bar)	15/15

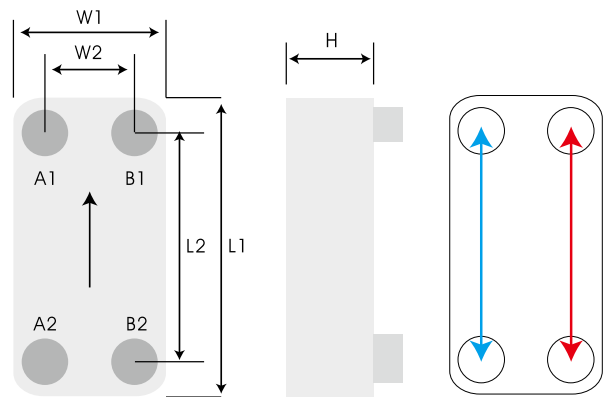

Model	L1 (mm)	L2 (mm)	W1 (mm)	W2 (mm)	H Thickness (mm)	Weight*(kg) (Without Connection)	Volume/ Channel (liter)
M050	306	250	106	50	10.0+2.40*N	1.04+0.136*N	0.055
M095	522	466	106	50	10.0+2.40*N	2.64+0.240*N	0.095
M205	528	456	246	174	11.5+2.40*N	6.27+0.544*N	0.232

N: number of plates

## Swimming Pool Heating

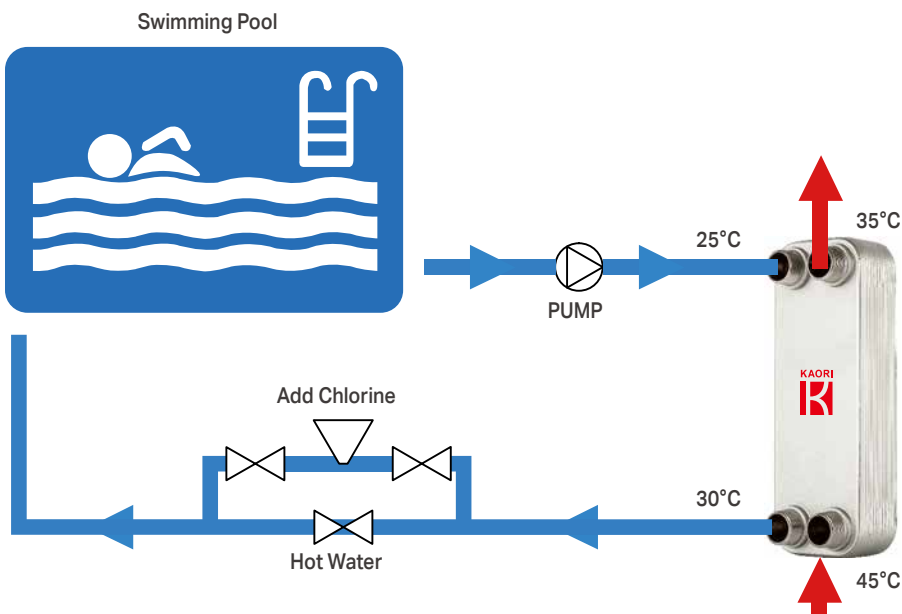

High Quality from **Taiwan**

## Standard Connections

Model	Thread Connections											Height (mm)
	PT/ NPT/ GB											
	3/8"	1/2"	3/4"	1"	1 1/4"	1 1/2"	2"	2 1/2"	3"	3 1/2"	4"	
010	○	●										13/15/20
015/025	○	○	●									13/15/20
020/021/022	○	○	○									20
030/031/032	○	○	○									20
035/036/037			○	○								20
040/041/042		○	○									20
045/046		○	●									27
050/051/052	○	○	○	○								20
060		○	○									20
070/071	○	○	○	○	○	●						27
085/086/087		○	○	○	○	○						27
095/096/097	○	○	○	○	●							27
105	○	○	○	○	○	●						27
110/111	○	○	○	○	●							27
140		●	●	○	○	○	○					27/54
200/201/202				○	○	○	○	○				27/54
205/206				○	○	○★	○★					27/54
210/211/212				○	○	○★	○★	○	●			27/42
215/216				○	○	○	○	●				27/54
300									○	○	○	54/81
400/401							○	○★	○★	○★	○★	54/81
415/416							○	○★	○★	●★		54/81
600/601							○	○★	○★	○★	○★	54/81

○ Male/Female Thread ○ Female Thread ● Male Thread ★ Flange

Model	Solder Connections																Height (mm)
	inch	1/4"	3/8"	1/2"	5/8"	3/4"	7/8"	1"	1 1/8"	1 3/8"	1 5/8"	2 1/8"	2 1/2"	2 5/8"	3 1/8"	4"	
	mm	6.6	9.73	12.9	16.15	19.25	22.36	25.6	28.8	35.25	41.5	54.3	63.5	67	79.4	105	
010	▲	▲															13/15/20
015	▲	▲	▲	▲													13/15/20
020/021/022	▲	▲	▲	▲													20
025/030/031/032	▲	▲	▲	▲	▲	▲	▲										20
040/041/042	▲	▲	▲	▲	▲	▲	▲										20
045/046	▲	▲	▲	▲	▲	▲	▲										20
050/051/052	▲	▲	▲	▲	▲	▲	▲	▲	▲								27
060	▲	▲	▲	▲	▲	▲	▲										20
070/071/085	▲	▲	▲	▲	▲	▲	▲	▲	▲	▲	▲						27
095/096/097	▲	▲	▲	▲	▲	▲	▲	▲	▲	▲	▲						27
105	▲	▲	▲	▲	▲	▲	▲	▲	▲	▲	▲						27
110/111	▲	▲	▲	▲	▲	▲	▲	▲	▲								27
140		▲	▲	▲	▲	▲	▲	▲	▲	▲	▲	▲					27/54
200/201/202			▲	▲	▲	▲	▲	▲	▲	▲	▲	▲					27/54
205/206			▲	▲	▲	▲	▲	▲	▲	▲	▲	▲					27/54
210/211/212				▲	▲	▲	▲	▲	▲	▲	▲	▲	▲	▲	▲		27/42
215/216			▲	▲	▲	▲	▲	▲	▲	▲	▲	▲	▲	▲			27/54
300															▲	▲	54/81
400/401							▲	▲	▲	▲	▲	▲	▲	▲	▲		54/81
415/416							▲	▲	▲	▲	▲	▲	▲	▲	▲		54/81
600/601							▲	▲	▲	▲	▲	▲	▲	▲	▲	▲	54/81

\*The above table is for reference only. Please contact KAORI representative for more information.

## Various connection designs fulfill different specifications

Connection types include: soldering (sweat), female/ male threaded, flange, combo, hydraulic, victaulic, quick, temperature control, opposite side...etc.

KAORI offers customize connections to fit your specific demand.







## Welding Procedure

Cleaning and degreasing the surface of copper pipes and BPHE connection before welding. To avoid oxidation in the copper pipes and BPHE, protect the inside with N2-gas. Place the BPHE on a flat surface and wrap a wet rag around the connection to protect the BPHE from excessive heating. Use a 40~45% silver alloy soldering rod to weld the copper pipe into the connection at a maximum temperature of 800°C. After soldering, clean and dry the connection and BPHE.

# Installation

## 1 Mounting

The BPHE should be mounted as below:

Setting	Vertical 	Horizontal 	Lying back 	Slanted 	Slanted 
<b>flow direction of product</b> <b>Counter flow</b> 	Evaporator: ○ Condenser: ○ Cooler: ○	Evaporator: ✕ Condenser: ✕ Cooler: ○	Evaporator: ✕ Condenser: ✕ Cooler: ○	Evaporator: ✕ Condenser: ✕ Cooler: ○	Evaporator: ✕ Condenser: ✕ Cooler: ○
<b>Diagonal flow</b> 	Evaporator: ○ Condenser: ○ Cooler: ○	Evaporator: ○* Condenser: ○* Cooler: ○	Evaporator: ✕ Condenser: ✕ Cooler: ○	Evaporator: ✕ Condenser: ✕ Cooler: ○	Evaporator: ✕ Condenser: ✕ Cooler: ○

\* Performance may be affected. For further information, please contact KAORI representative.

Fig. 1

\* Vibration dampener or other absorbing devices are also recommended.

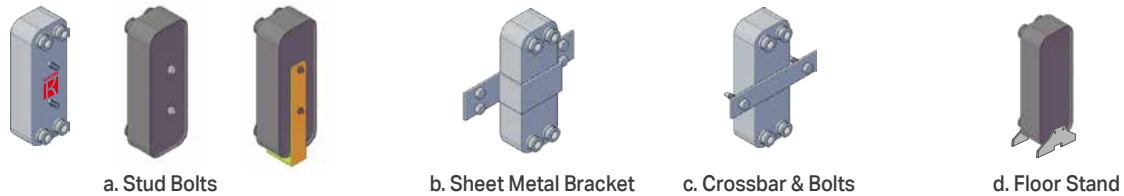

\* The installation fixture of the diagram is for reference only. The product itself does not include the above accessories. If you have related requirements, please contact KAORI representative.

Fig. 2

## 2 Softening Treatment of Cooling Tower Water

Softening treatment and regular maintenance for cooling tower can reduce the scale clogging problem. While using chemical additives to do the cleaning, the concentration of the additive should be carefully controlled. Avoid using corrosive additives. If stainless steel and copper react to the corrosive content, it will reduce the pressure resistance on the brazing joints and possibly lead to internal or external leakages. To avoid the problem mentioned above, please refer to the below data for proper chemical additives:

PH: 6~8                       $SO_4^{-2} < 30\text{mg/L}$   
 Cl<sup>-</sup> < 50ppm (<100°C)       $NH_4^+ < 0.1\text{mg/L}$

## 3 Prevention of Water Hammer

Water hammer occurs when the pipes carry incompressible fluids and the flow suddenly changes its velocity. The most common case occurs when one rapidly closes the solenoid valve and thus, causes instant pressure in the pipes. This will damage the valve, heat exchanger and other equipment. In order to avoid the problem mentioned above, installation of pressure suction pipe, water hammer arrestor, air chamber...etc is highly recommended.

## 4 Cleaning

While fouling in the BPHE, back flushing is always possible to remove most of the soft debris that is blocking the inside. Weak acids with concentration less than 5%; for example: citric acid, oxalic acid add in a tank. Circulate the cleaning solution. Before restarting the system, flush the BPHE with large amounts of fresh water to purge any remaining acid solution. If the acidity is too high, the copper and stainless steel inside the BPHE may be etched or corroded.

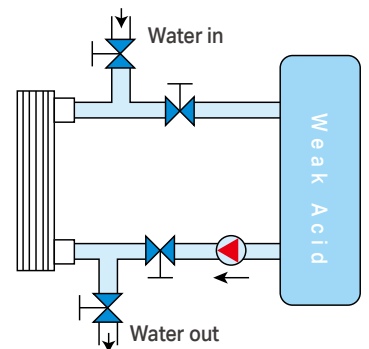

Fig. 3 Cleaning

KAORI



KAORI HEAT TREATMENT CO., LTD.

## Professionals in Customized Heat Exchangers



KAORI reserves the right to make changes without prior notice.  
2024.01/1,000



ON, Head Office

[www.ecotherm.ca](http://www.ecotherm.ca)

QC & Eastern Canada

1-866-HVACMAX (482-2629)

BC & Western Canada

[sales@ecotherm.ca](mailto:sales@ecotherm.ca)